



EZ3600V

User manual



Ft. Atkinson, Wisconsin USA



Panningen, the Netherlands

www.digi-star.com

TABLE OF CONTENTS

FEED MANAGEMENT SOFTWARE.....	1
CAB CONTROL (WIRELESS)	2
SAFETY DURING USE.....	3
Check system before use	3
Cleaning	3
Charging battery and welding	3
OVERVIEW WEIGHING INDICATOR.....	4
OPERATION.....	6
Switching on the weighing indicator	6
USING EZ3600(V) AS A DATA TRANSFER UNIT.....	7
DATA TRANSFER	8
USB mode.....	8
DataLink modes	8
Weighing indicator data formats	8
LOADING AND FEEDING IN COMPLETE LOAD MODE	9
Loading recipes.....	9
Resizing recipe weight.....	9
Feeding groups	10
LOADING AND FEEDING IN RECIPE AND GROUP LIST MODE	11
Loading the recipe.....	11
Resizing recipe weight.....	11
Feeding groups	12
ADVANCED FUNCTIONS	13
Partially feeding groups.....	13
Return to the skipped ingredient.....	13
Changing the feeding cycle number	13
Clearing the indicator memory.....	14
Re-using recipe / group data	14
Adding a group to group list.....	14
EZ3600(V) FRONT PANEL PROGRAMMING	16
PROGRAMMING RECIPES	17
Changing the programming method	17
Changing ingredient names.....	17
Printing an ingredient name.....	18
Programming a new recipe.....	18
Changing ingredient amounts in the recipe.....	19
Deleting recipe	20
Calling up a recipe.....	20
PRINTING RECIPES	21
Printing a single recipe	21
Printing all the recipes	21
LOADING AND DOSING OUT RECIPES	22
Loading recipe according to amount per animal	22
Dosing out recipe	23
ADDITIONAL FUNCTIONS.....	24
Holding the displayed amount	24
Printing.....	24
Backlight intensity.....	24
Deleting accumulative ingredient amounts	25
COMMONLY USED DIRECT ACCESS NUMBERS.....	26
Pre-alarm	26
Automatically advancing ingredients.....	26
Tolerance	26
Group tolerance.....	27

Delay time	27
Automatically advancing to next ingredient / Manually advancing to next group	28
Drive ratio.....	28
Weighing indicator ID / feed mixer ID	28
Radio number.....	29
Changing the recipe amount on the weighing indicator.....	29
Setting the time	29
Setting the date	30
TMR Tracker or Front Panel programming	30
LIST WITH DIRECT ACCESS NUMBERS.....	31
TROUBLE SHOOTING	34
INSTALLATION	36
Mounting the indicator	36
Load cell direction	36
Connecting the cables.....	37
Connecting load cells to J-Box	38
Changing setup and calibration numbers.....	38
OPTIONAL EQUIPMENT.....	39
Rotation counter sensor	39
Transmitter/receiver	39
Remote displays.....	39

APPENDIX A1: EC DECLARATION OF CONFORMITY

All rights reserved. Reproduction of any part of this manual in any form whatsoever without Digi-Star's express written permission is forbidden. The contents of this manual are subject to change without notice. All efforts have been made to assure the accuracy of the contents of this manual. However, should any errors be detected, Digi-Star would greatly appreciate being informed of them. The above notwithstanding, Digi-Star can assume no responsibility for any errors in this manual or their consequence.

© Copyright! 2008 Digi-Star, Fort Atkinson (U.S.A.).

FEED MANAGEMENT SOFTWARE



A full featured Windows® based system that offers powerful and easy to use features.

>>For additional information, see www.digi-star.com

CAB CONTROL (WIRELESS)



Features

- Wireless remote operation in front loader with full key control of the weighing indicator mounted on the feed mixer.
- Thanks to Cab Control the weight can be easily readout in your front loader.
- Ingredients can be loaded more accurately.

Functions

- Communicates with several feed mixers
- Easily call-up recipes without leaving the front loader.
- Manual advance when loading ingredients.

Specifications

- Built-in wireless 2.4 GHz radios
- Range up to 1000ft (300m)
- 24 channels
- 12 or 24 Vdc systems

>>For additional information, see www.digi-star.com

SAFETY DURING USE



Caution

Check system before use

Before you are going to use the Digi-Star weighing system you need to check the proper working of the system by charging all weighing points with a known weight.

Digi-Star cannot be held responsible for deviations and problems arising from incorrect use of the weighing indicator, incorrect calibration or settings. Furthermore Digi-Star cannot be held responsible for deviations and problems arising from technical problems to the system.

Cleaning

Do not use running water (high pressure cleaners, hoses) to clean the indicator.

Charging battery and welding

During welding you need to remove the weighing bars to avoid damaging. If this is not possible, you need to place the "ground" clip as close to the welding point as possible, in order to avoid that current can flow through the weighing bars.

Digi-Star cannot be held responsible for problems arising from welding or charging of the battery.

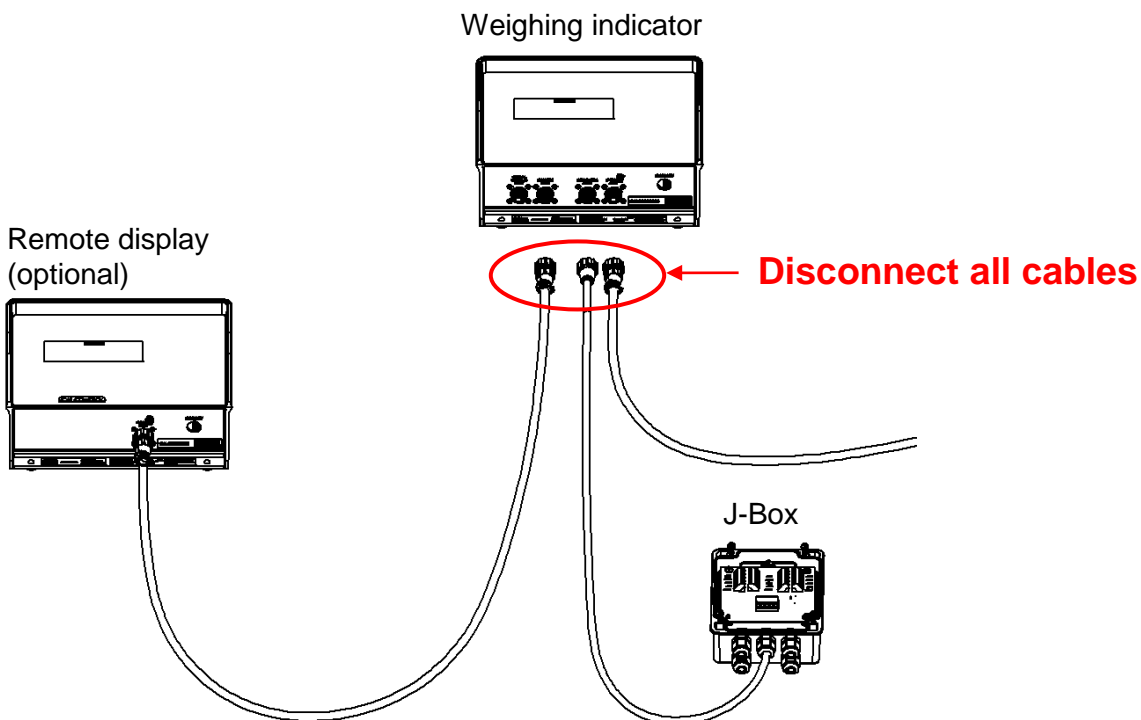



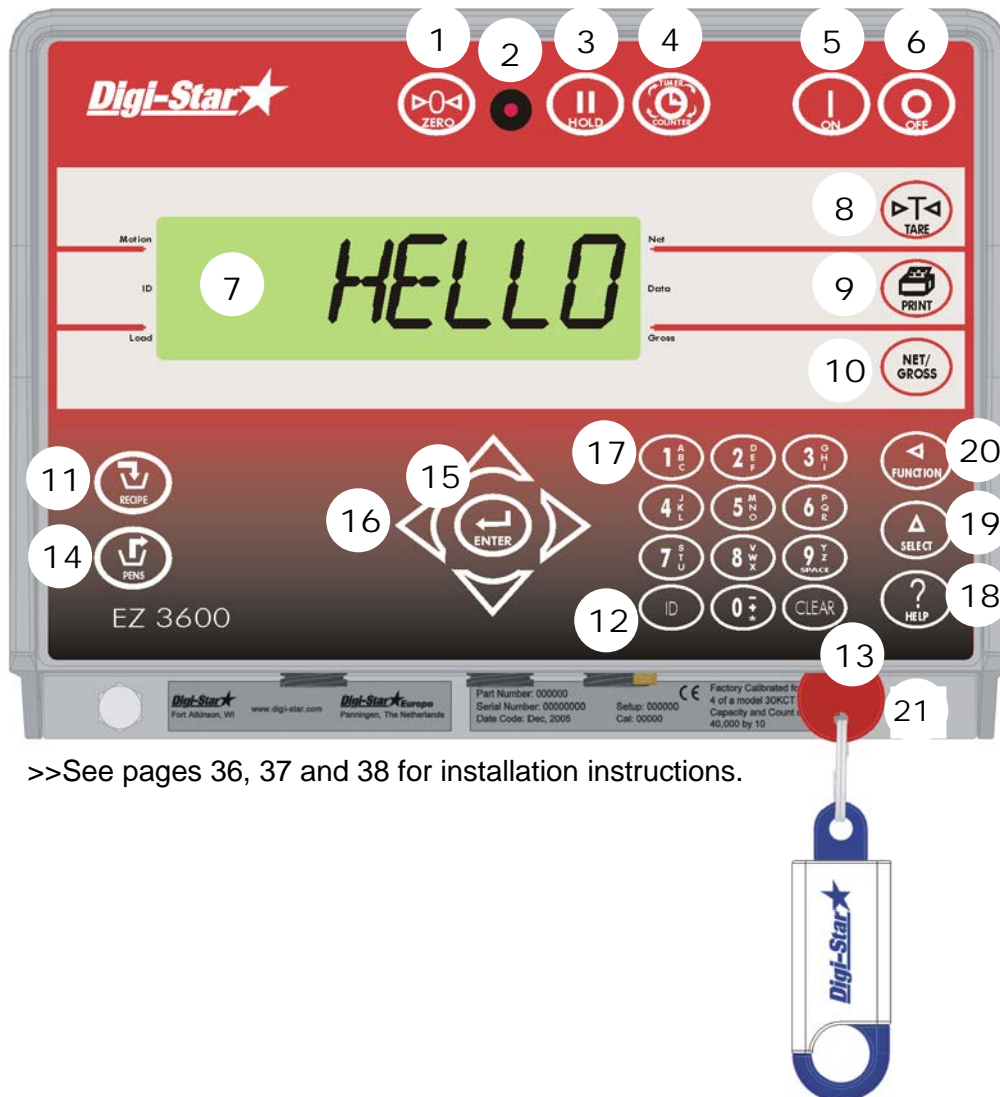



OVERVIEW WEIGHING INDICATOR



>>See pages 36, 37 and 38 for installation instructions.

1. – press and hold for 3 seconds to zero balance the weighing indicator.
2. Warning light pre-alarm – light flashes and alarm sounds when weight is within preset limit.
3. – to hold displayed weight when moving the machine.
4. – to set mixing time
5. – to switch on weighing indicator . Press this key while the weighing indicator is on to run the self test.
6. – to switch off weighing indicator.
7. Display – to display actual values and settings.
8. – to temporarily zero the weighing indicator [Net mode].
9. – to register or print the displayed weight.
10. – to toggle between net and gross weights.
11. – to select recipes.
12. – to enter user and feed cycle numbers. Any user number can be entered as long as this number has not been assigned by the management software.

13.  – to clear <Backspace>
14.  – to start dosing out recipe for groups [List mode]. See page 12.
15.  – to confirm modification or select the next item.
16. Arrow keys – to scroll through a list of information.
17. Keyboard – to enter numbers and letters.
18.  – to display extra information.
19.  – to display extra tasks.
20.  – to perform the selected task.
21. USB stick – to transfer data from computer to weighing indicator and vice versa.

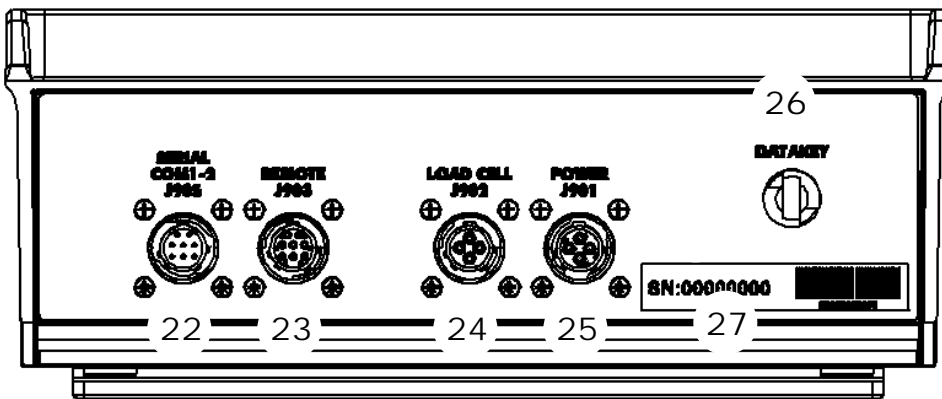

22. Serial port/printer port – communication with inputs and outputs of the computer and other digital devices (optional).
23. Port for remote display – to connect the remote display (optional).
24. Load cell port – to connect the J-Box cable.
25. Power supply port – to connect the power supply cable.
26. USB port – to insert the USB stick to upload/download data.
27. Serial number

>>See pages 36, 37 and 38 for installation instructions.

OPERATION

Switching on the weighing indicator



1. Press .



2. Enter the user number, if required.

3. Press .

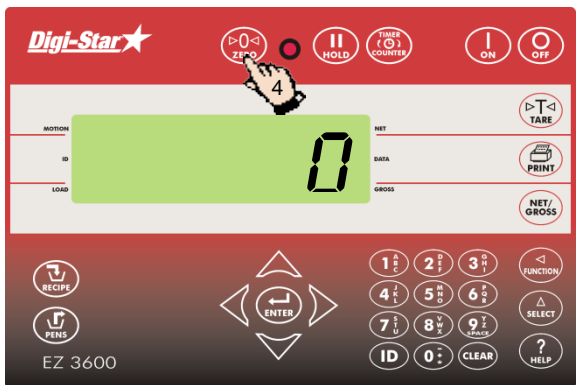

4. Press and hold  for 3 seconds to zero balance the weighing indicator.

USING EZ3600(V) AS A DATA TRANSFER UNIT

Recipes can be programmed using the TMR Tracker software and sent to the EZ3600(V) unit via USB stick or DataLink. When running in “PC” mode it is not possible to program a recipe using the front panel.

To set unit to PC programmable see page 30 *TMR Tracker or Front Panel programming*.

DATA TRANSFER

USB mode





1. Insert the USB stick in the weighing indicator.
2. Press  to upload data.

Note: If the weighing indicator displays uncompleted recipes in the memory, press  to overwrite this data. Remove USB stick after data has been transferred.

To download data of completed recipes: Insert the USB stick in the weighing indicator. The weighing indicator automatically sends data to the USB stick.

Remove the USB stick.

DataLink modes

Operation	Displayed message
DataLink connects with the weighing indicator	←PC→
DataLink sends data to the weighing indicator	DL←IN
The weighing indicator gives a message that all data has been received.	NEW DATA
Weighing indicator connects with DataLink	←PC→
Weighing indicator sends complete data to DataLink	DL→OUT
To send data to the PC, if not all recipes have been fed. Press  until a message [right column] appears on the display. Press  to select this.	EZ→PC
The weighing indicator marks uncompleted recipes as being completed and sends data of the completed recipes to DataLink.	

Note: After data has been sent, uncompleted recipes will be deleted.

Weighing indicator data formats

Data can be sent to the weighing indicator in two different modes:

Complete load mode

Each load is prepared by the TMR Tracker software. In this mode groups are assigned to recipes and an accurate load is prepared.

Recipe and group list mode

The TMR Tracker software sends the recipe and group data in two separate lists. The operator selects the recipe to be prepared and the dose outs per group.



LOADING AND FEEDING IN COMPLETE LOAD MODE

Loading recipes



1. Press 





1. The weighing indicator displays recipe, group number and feeding number in succession.
2. Press  and  to select the required recipe.
3. Press  to start the recipe selected.

Resizing recipe weight



If the RESIZE function is activated, the recipe amount for the group(s) can be adjusted.

1. Enter the new recipe amount or keep the original amount.
2. Press . The weighing indicator recalculates the recipe.

Note: Press  to change the number of animals instead of the recipe amount. After the number of animals has been changed, the weighing indicator will automatically adjust the recipe amount.

Press  to accept the recipe amounts of the group(s) without adjusting them.

If the weighing indicator indicates that the resized recipe exceeds the capacity of the feed mixer, press  to ignore this message.



1. The first ingredient and the corresponding amount will flash on the display.
2. As soon as the amount starts to approach zero the alarm light starts flashing and you will hear an alarm signal.
3. a) Manually advance next ingredient: When the ingredient amount to be loaded has been reached, press to accept this amount. Press again to advance to the next ingredient.
 b) Automatically advance next ingredient: When the ingredient amount to be loaded has been reached, the weighing indicator will automatically advance to the next ingredient.
 Note: See pages 26, 27 and 28 for settings.

Note: To load the ingredients in a different order, press or to select the required ingredient. Press to start loading this ingredient.

Feeding groups



When the ingredients have been loaded, the weighing indicator will show the first group to be fed.

1. a) Manual advance:
 Press to select the group to be fed. When the amount to be fed has been dosed out, press to accept this. Press again to advance to the next group,
 or
 b) Automatic advance:
 When the amount to be fed has been dosed out, the weighing indicator will automatically advance to the next group.

After the last group has been fed, following message will appear on the display:
RECIPE COMPLETE.





Note: Do **not** press .

To feed the groups in a different order, press or to select the required group. Press to start feeding this group.

LOADING AND FEEDING IN RECIPE AND GROUP LIST MODE

Loading the recipe





1. Press .
2. On the display appears, for example:
RECIPE DRY COW TOT - 2500
3. Press  and  to select the required recipe.
4. Press  to start loading the selected recipe.

Resizing recipe weight





If the RESIZE function has been activated, the recipe amount can be adjusted.



1. Enter the new recipe amount or keep the original amount.
2. Press . The recipe is recalculated.

Note: If the weighing indicator indicates that the resized recipe exceeds the capacity of the feed mixer, press  to ignore this message.



1. The first ingredient and the corresponding amount will flash on the display.
2. As soon as the amount starts to approach zero the alarm light starts flashing and you will hear an alarm signal.
3. a) Manually advance next ingredient: When the ingredient amount to be loaded has been reached, press  to accept this amount. Press  again to advance to the next ingredient, or ...

b) Automatically advance next ingredient: When the ingredient amount to be loaded has been reached, the weighing indicator will automatically advance to the next ingredient.
See pages 26, 27 and 28 for settings.

Note: To load the ingredients in a different order, press  or  to select the required ingredient. Press  to start loading this ingredient.

Feeding groups

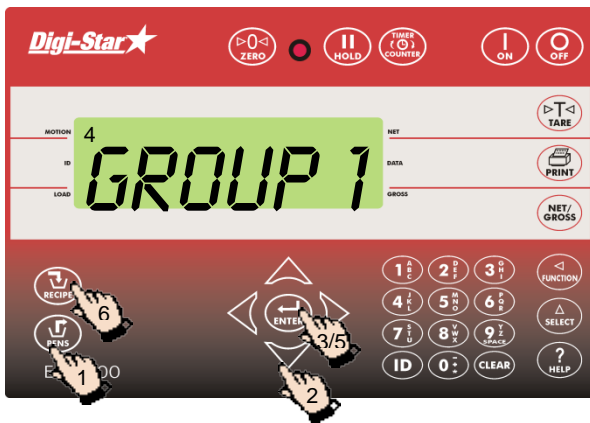



1. After the last ingredient has been loaded, *RECIPE COMPLETE* will appear on the display. Press . The weighing indicator shows the groups to be fed.
2. Press or to select the required group.
3. Press .
4. The weighing indicator shows the group to be fed and the corresponding recipe amount. Feeding can be started.
5. a) Manually advance: When the recipe amount to be fed has been dosed out, press to accept this. Press again to advance to the next group.
or
b) Automatically advance: When the recipe amount to be fed has been dosed out, the weighing indicator will automatically advance to the next group to be fed.
6. When the group(s) have been fed, press to select the recipe for the next group to be fed.

See pages 26, 27 and 28 for settings.

ADVANCED FUNCTIONS

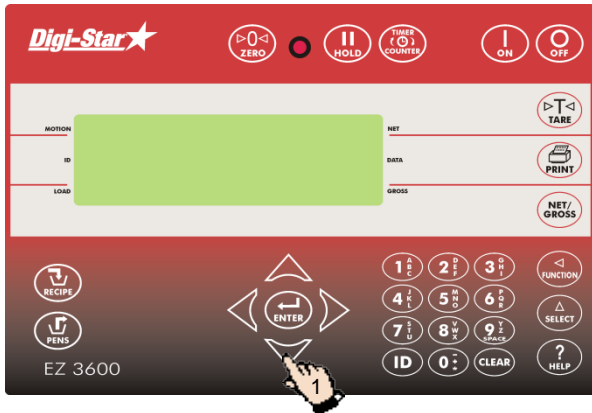
Partially feeding groups



1. Press  to advance to next group without finishing feeding the current group.



Note: If you have set the group tolerance and feeding is stopped before the preset recipe amount is reached, an alarm will sound and the weighing indicator displays:

*PEN UNDERFERED - PRESS PRINT
TO REMOVE THIS PEN FROM LIST -
PRESS ON TO KEEP PEN*

To set group tolerance, see page 27.

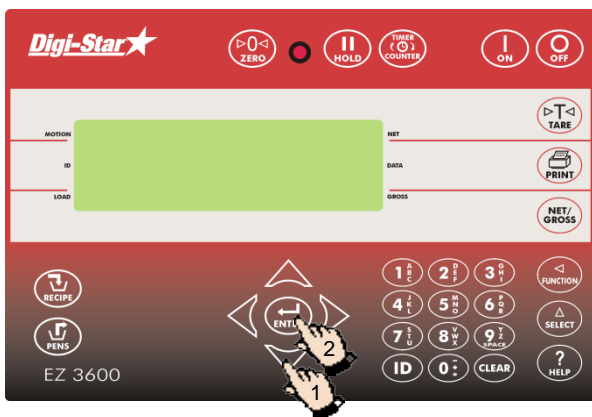
Return to the skipped ingredient





1. Press  or  to return to the skipped ingredient.
2. Press .

Note: If the ingredient amount has changed by more than 4 counts, this ingredient can no longer be selected.

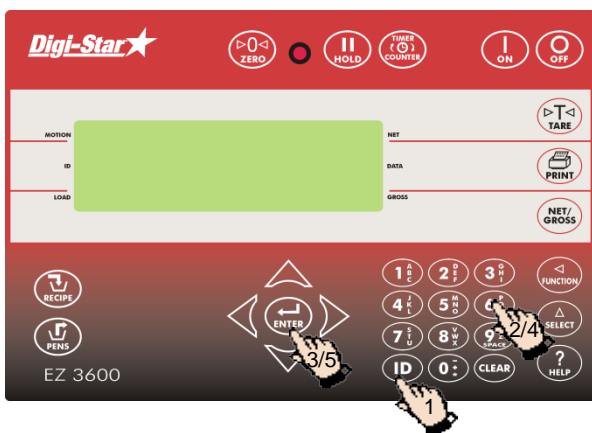
Changing the feeding cycle number



1. Press .
2. Enter user number.
3. Press .
4. Enter feeding number (1-9).
5. Press .

Clearing the indicator memory

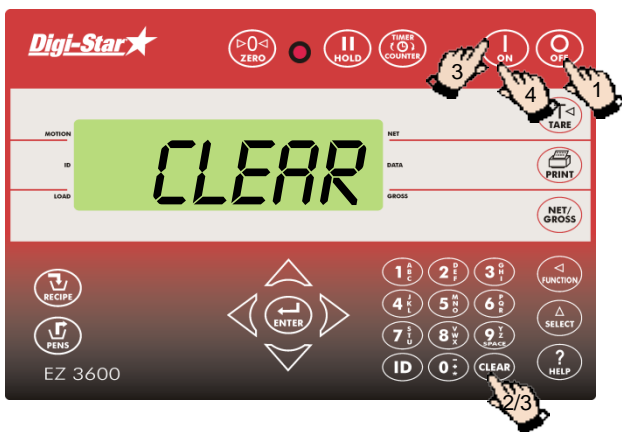

1. Press **OFF** .
2. Press and hold **CLEAR** .
3. Press **ON** , while holding **CLEAR** . The weighing indicator will successively show:
ON=ERASE CLEAR=REUSE NET=EXIT
Release **CLEAR** .
4. Press **ON** .

Re-using recipe / group data



1. Press **OFF** .
2. Press and hold **CLEAR** .
3. Press **ON** while holding **CLEAR** . The weighing indicator will successively show:
ON=ERASE CLEAR=REUSE NET=EXIT.
Release **CLEAR** .
4. Press **CLEAR** again to re-use recipe and group data.



Note: The weighing indicator re-uses the recipe and group information stored in the weighing indicator. The loaded ingredient amounts and fed recipe amounts will be removed. Download the complete data to the USB stick, before re-using the recipe and stored group data. For continuous re-use, set number **466** from the list with direct access number (D.A.N.-list) to ON. See page 33.

Adding a group to group list



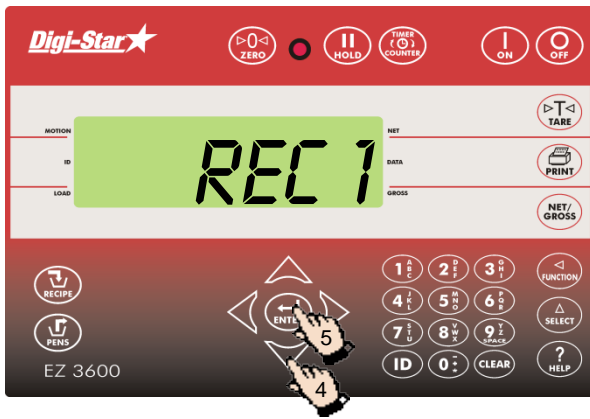

1. Enter group name or number.
2. Press **PENS** .
3. Press **ENTER** to add the group.

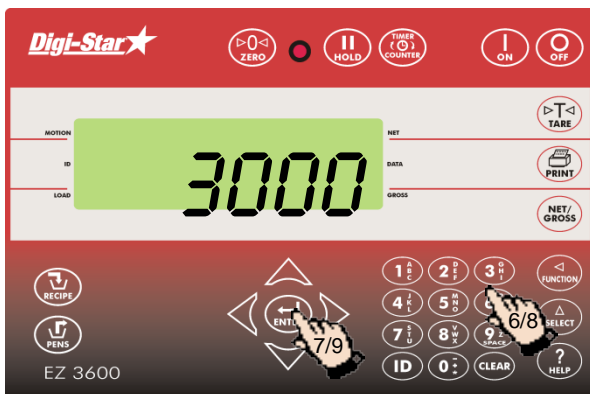

4. Press  or  to select the required recipe.
5. Press .



6. Enter the recipe amount to be fed to the group.
7. Press .
8. Enter the number of animals in this group.
9. Press .



10. If you work with zones, the following will appear on the display:
ENTER ZONE 0-9
11. Enter the required zone.
12. Press .

EZ3600(V) FRONT PANEL PROGRAMMING

Recipes can be programmed using the EZ3600(V) front panel.

To set front panel programming see page 30 *TMR Tracker* or *Front Panel programming*.

PROGRAMMING RECIPES

The ingredients in a recipe can be entered in three different ways:

1. Amount per animal (standard setting)

Enter the amount of ingredient per animal per recipe. For example, 9 kg silage and 8 kg corn. Depending on the number of animals to be fed, the weighing indicator will calculate the total amount of the ingredients to be prepared: For example, with 100 animals this will be 900 kg silage and 800 kg corn.

2. Percentage (%) per ingredient



Enter the amount of ingredient per recipe as a percentage (%). For example, 55% silage and 45% corn. The weighing indicator will calculate the total amount to be prepared per ingredient: For example, with a total weight of 1000Kg this will be 550 kg silage and 450 kg corn. Attention; the total must be 100%.

3. Amount per ingredient

Enter the required total amount of ingredient per recipe. For example, 2500 kg silage and 2000 kg corn.

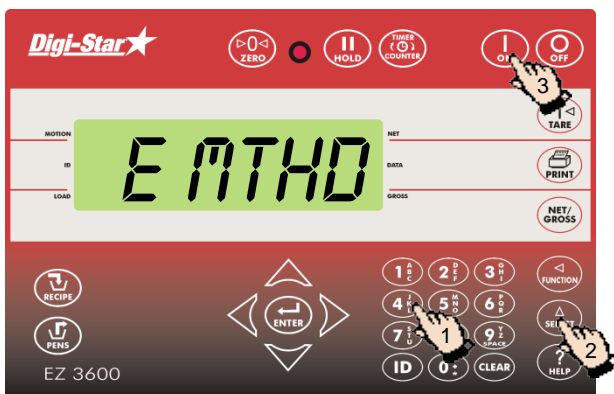
Changing the programming method
[E-MTHD]





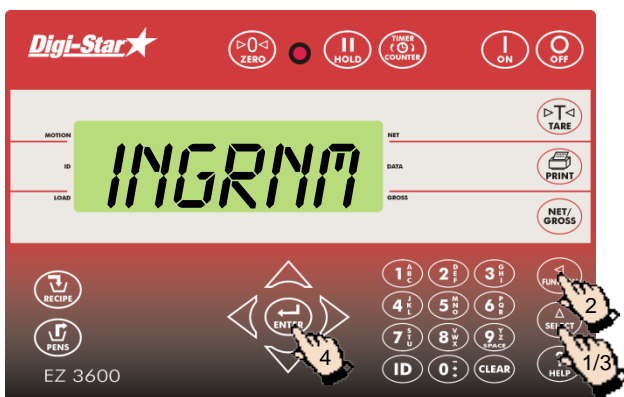

1. Enter **441** and press .
2. Press  repeatedly to select the required programming method for blends.
 - 1 = Amount per animal
 - 2 = Percentage (%) per ingredient
 - 3 = Amount per ingredient
3. Press  to confirm the selected programming method.

Changing ingredient names

The standard ingredient names can be changed as required:



1. Repeatedly press , until *INGRNM* is displayed.
2. Press .
3. Press  to select the ingredient to be changed.
4. Press  to change the name. *EDIT* will briefly be displayed, followed by a flashing cursor.

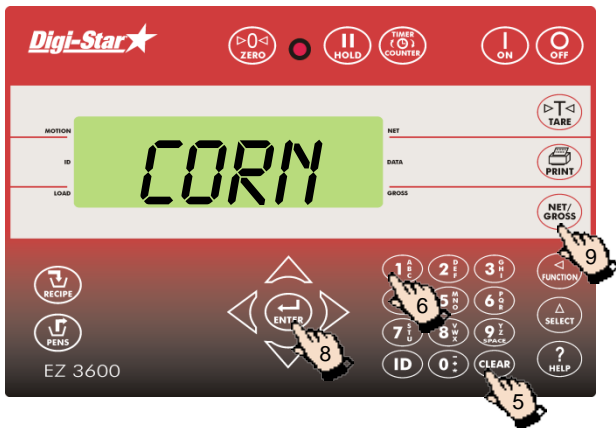

5. Press **CLEAR** repeatedly to delete an ingredient.
6. Press **1^A_B_C** x 1 to enter the number 1; Press 2x is A, 3x is B and 4x is C. Use this method to enter all the letters of the alphabet using the numeric keyboard.
7. When you have entered a letter or number, wait briefly before entering the next number or letter.
8. Press **ENTER** to confirm.
9. Press **NET/GROSS** to return to normal weighing mode.

Printing an ingredient name



1. Repeatedly press **RECIPE**, until *INGRNM* is displayed.
2. Press **FUNCTION**.
3. Press **PRINT** to print all ingredients and the total amounts loaded per ingredient.

Programming a new recipe

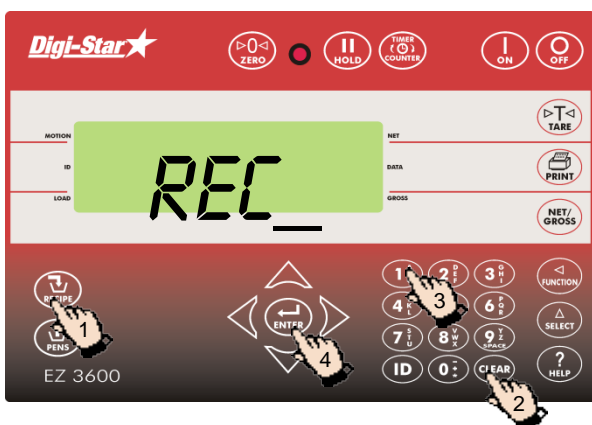

1. Press and hold **RECIPE** until the weighing indicator emits a high pitched signal and *PROGRAM* is displayed. The first programmed recipe or *REC__* will be displayed.
2. Press **CLEAR** or,
3. Enter the required recipe number.
4. Press **ENTER** to confirm the entered recipe number.



5. Use and to run through the list with ingredients.



6. Press to select the displayed ingredient.
7. Enter the required ingredient amount*.
8. Press to confirm the entered amount.
9. Repeat steps 5 thru 8 for the other ingredients in the recipe to be programmed.

* With the programming method *Percentage (%) per ingredient* enter 75%, for example, as 75.00 and 5.75% as 5.75.

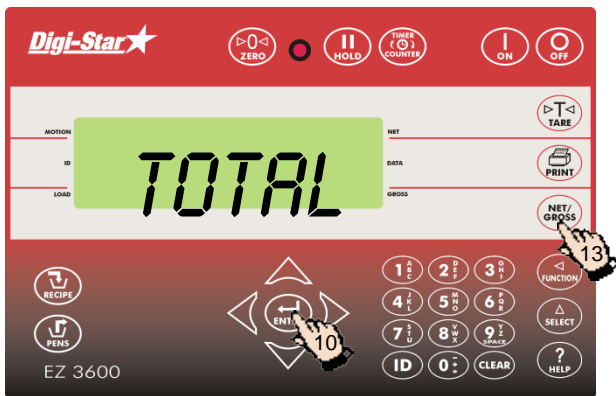

10. Press to confirm the entered recipe.
11. The weighing indicator calculates and displays the total amount of the recipe (*TOTAL*).
12. Repeat steps 1 thru 11 for the other recipes to be programmed.
13. Press to quit program mode.

Changing ingredient amounts in the recipe

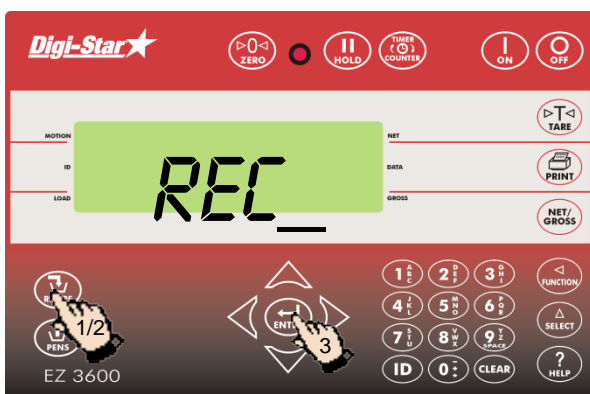

1. Press and hold until the weighing indicator emits a high pitched signal and *PROGRAM* is displayed.
2. Press repeatedly until the recipe number to be changed is displayed.
3. Press to select this recipe.

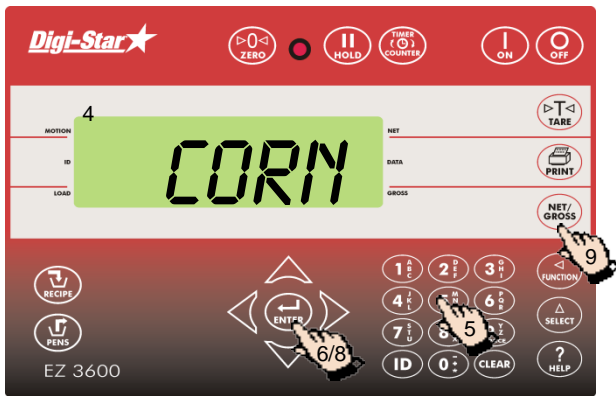

4. The first ingredient name is displayed, followed by *AMOUNT*.
5. Enter the new amount.
6. Press **ENTER** to save the new amount and continue with the following ingredient.
7. Repeat steps 5 and 6 for the other ingredients in the recipe.
8. Press **ENTER** to save the changed recipe.
9. Press **NET/GROSS**.

Note: It is only possible to change ingredient amounts. To add new ingredients to the recipe, first delete the recipe, then program it again.

Deleting recipe

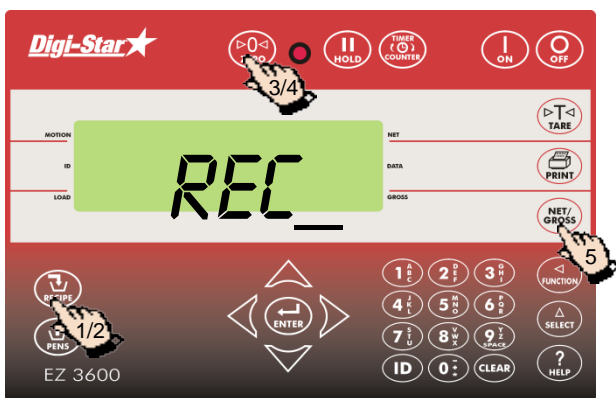

1. Press and hold **REC** until the weighing indicator emits a high pitched signal and *PROGRAM* and the first recipe number are displayed in succession.
2. Press **REC** repeatedly until the required recipe number is displayed.
3. Press and hold **ZERO** until *PRESS ZERO TO DELETE RECIPE - PRESS NET/GROSS TO QUIT* are displayed.
4. Press **ZERO** to delete this recipe.
5. Press **NET/GROSS** to return to normal weighing mode.

Calling up a recipe

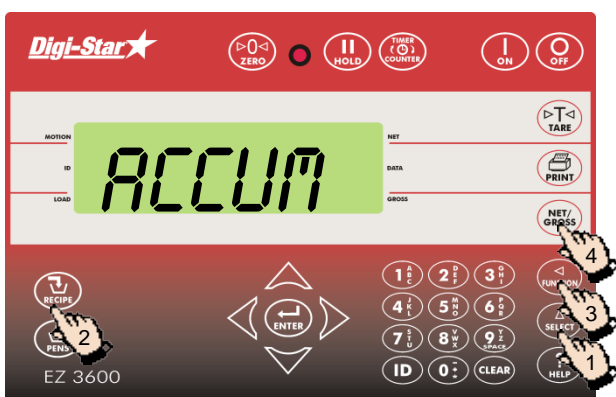





1. Press **SELECT** repeatedly until *ACCUM* is displayed.
2. Press **REC** repeatedly until the required recipe is displayed.
3. Press **FUNCTION** to display the various ingredients in the selected recipe.
4. Press **NET/GROSS** to return to normal weighing mode.

PRINTING RECIPES

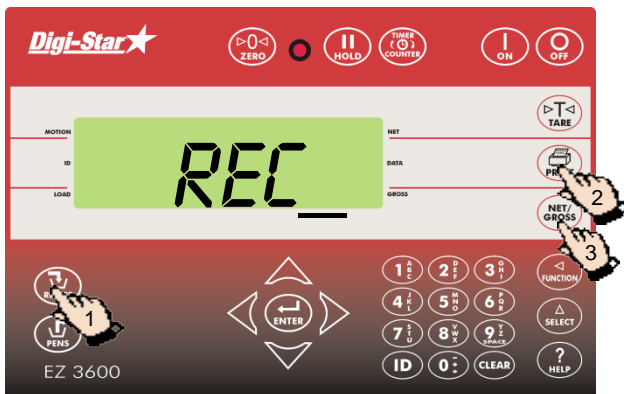
Printing a single recipe





Note: The serial port (optional) must be installed in order to print.

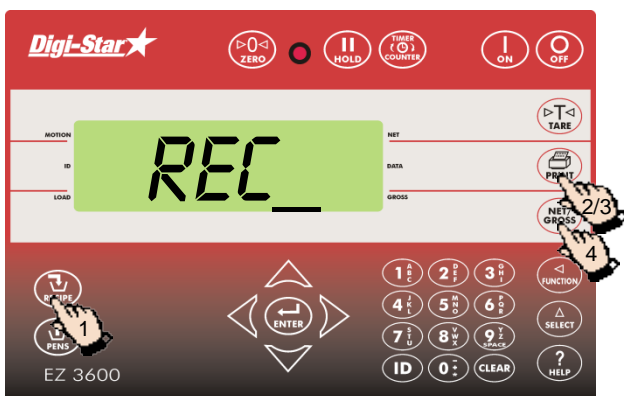

1. Press  repeatedly until the required recipe is displayed.
2. Press  to print this recipe.
3. Press  to return to normal weighing mode.

Printing all the recipes



1. Press  to display the first recipe.
2. Press  to print this recipe.
3. Press  again to print all the recipes saved in the memory.
4. Press  to return to normal weighing mode.

LOADING AND DOSING OUT RECIPES

Loading recipe according to amount per animal



1. Press repeatedly until the recipe to be loaded is displayed.
2. Press to start the recipe selected.
3. The weighing indicator displays *LOAD RECIPE*.



4. *ANIMAL* is displayed.

Note: If you work using a percentage per ingredient or an amount per ingredient, the total amount *TOTAMT* will be displayed.

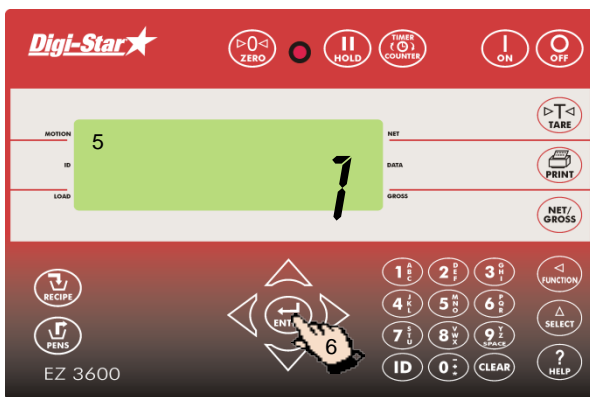

5. A flashing number will be displayed. Change this number into the number of animals to be fed.
6. Press .

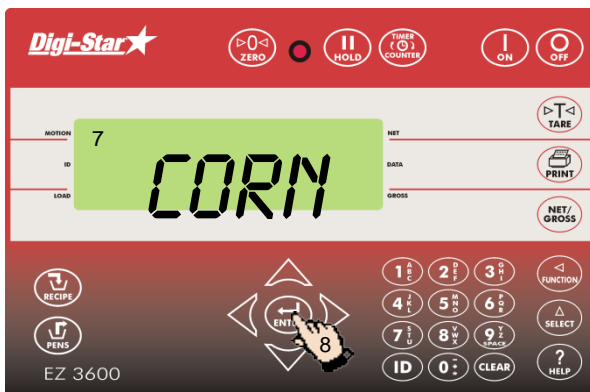

7. The weighing indicator displays the name and amount of the ingredient to be loaded. As soon as the ingredient is loaded, the weighing indicator will count down to zero.
8. Press to advance to the next ingredient.

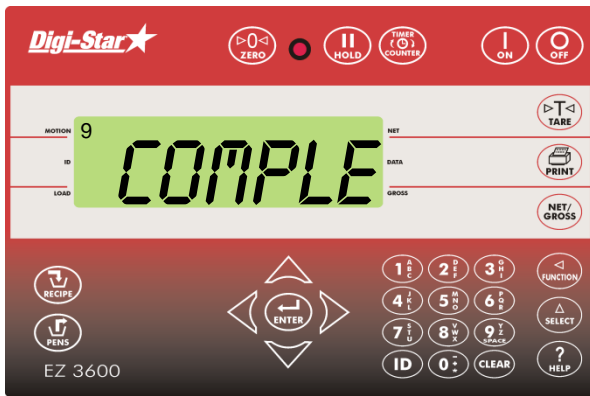

(To set automatic advance, see page 33).

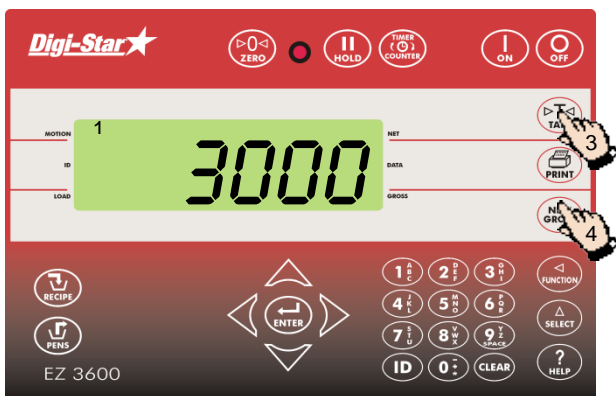

- After the final ingredient has been loaded *RECIPE COMPLETE TOTAL LOADED XXX KG* will be displayed.

Dosing out recipe





- The display shows the total amount of loaded recipe.
- As soon as dosing out starts the weighing indicator will count down to zero.
- Press  to temporarily set the weighing indicator to 0. This function can be used to see how much has been dosed out per group, if several groups are being fed.
- Press  to read out the remaining weight at any time.

ADDITIONAL FUNCTIONS

Holding the displayed amount

In Hold mode the displayed weight remains on the display while moving the feed mixer.



1. Press  to hold the displayed weight.
2. Press  to return to normal mode.

If an ingredient is loaded while the weighing indicator is in Hold mode, press  to exit hold mode.

Printing

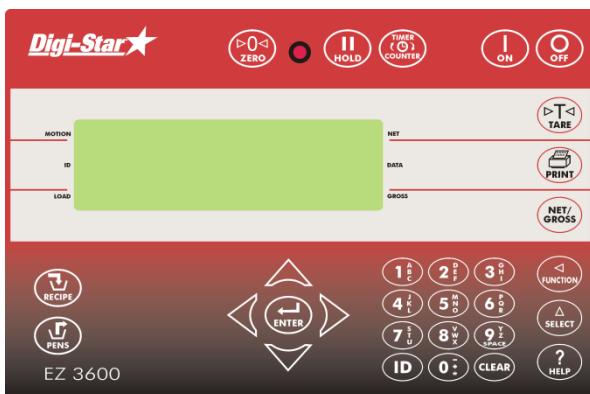

Note: The serial port (optional) must be installed to print data.



Reference: technical manual D3648 on www.digi-star.com

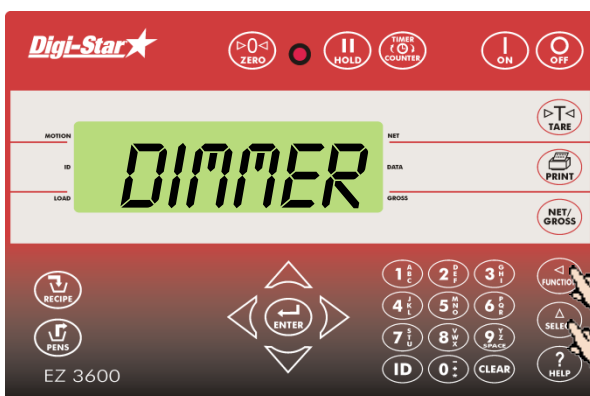

Backlight intensity

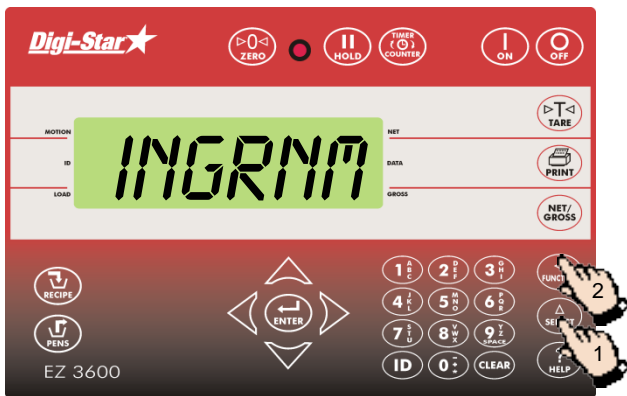

1. Press , until *DIMMER* appears on the display.
2. Press  to reduce the backlight intensity by 60%. Press  again to return to full intensity.

Deleting accumulative ingredient amounts







1. Repeatedly press  , until *INGRNM* is displayed.
2. Press  . *PROGRAM* will briefly flash on the display, followed by the first ingredient.

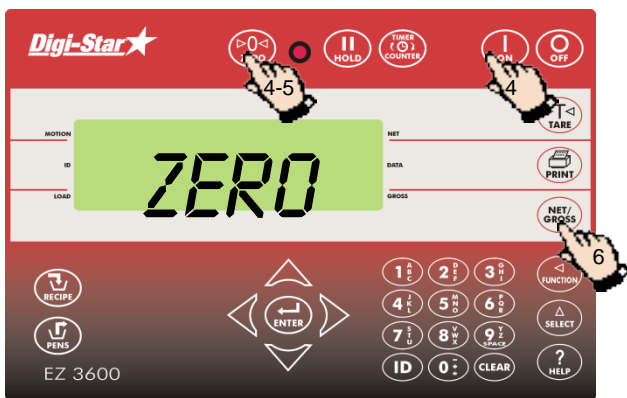

3. Press  or  to select the required recipe.



4. Press and hold  . Press  .The following text is displayed: *PRESS PRINT TO REPRINT- PRESS ZERO TO DELETE ACCUMULATION – PRESS NET/GROSS TO QUIT.*
5. Press  to delete the total amount for corn.
6. Press  .





COMMONLY USED DIRECT ACCESS NUMBERS

Pre-alarm

[P-ALM]

Message when the preset amount to be loaded is almost reached.



1. Enter **401**.
2. Press .
3. Press  again to select *WEIGHT* or *PERCENT*.
4. Press .
5. Enter the pre-alarm value in weight or percent.
6. Press .

Automatically advancing ingredients



When automatically advancing to next ingredient, the weighing indicator will automatically advance to the next ingredient as soon as the current ingredient has been loaded, taking the set tolerance and delay time into account.

Tolerance

[TOLER]

Tolerance is a percentage of the desired ingredient amount. When reaching the *Desired amount* minus *Tolerance*, the weighing indicator will accept the loaded amount and automatically advance to the next ingredient, depending on the delay time.



1. Enter **442**.
2. Press .
3. Press , until the desired percentage (tolerance) appears on the display:
OFF, 0.5, 1 - 5, 7, OR 10.
4. Press .

Group tolerance

[T MTHD] & [PENTOL]

Only available in group list mode.

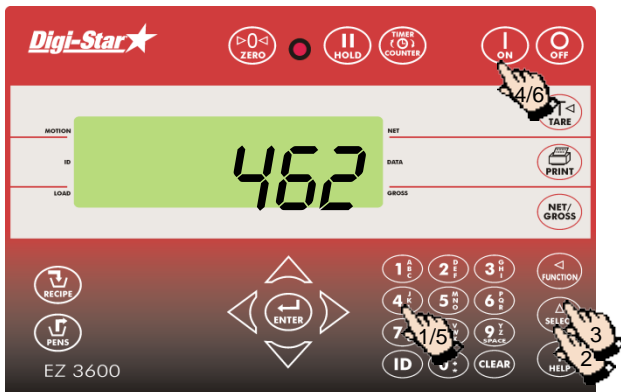

1. Enter **462**.
2. Press **SELECT**.
3. Press **SELECT** again to select *WEIGHT* or *PERCENT*.
4. Press **ON**. On the display appears: *PENTOL*.
5. Enter the required value in weight or percent.
6. Press **ON**.

Delay time

[DELAY]

Enter the time that the weighing indicator should wait before advancing to the next ingredient to be loaded.

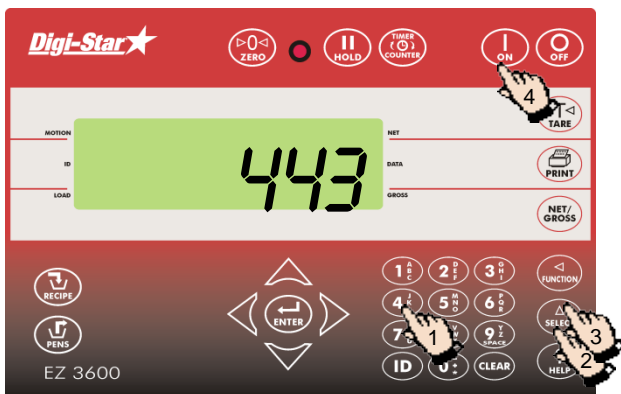

1. Enter **443**.
2. Press **SELECT**.
3. Press **SELECT**, until the required delay time (seconds) appears on the display: *MANUAL, 1, 2, 3, 5, 7, 10, 20, 30, OR 60*.
4. Press **ON**.



Note: If automatically advancing to the next ingredient is not required, set this setting to *MANUAL*.

Automatically advancing to next ingredient / Manually advancing to next group

[MANPEN]

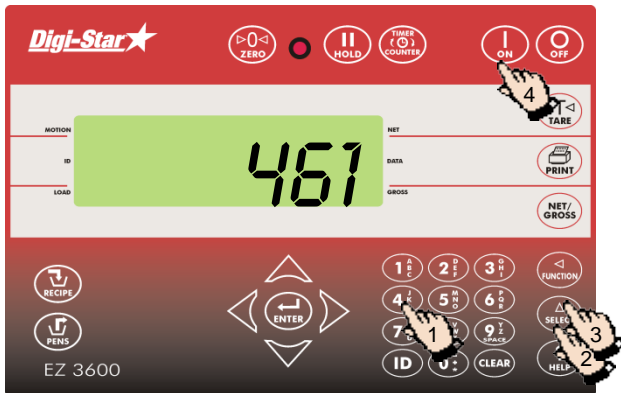
Automatically advancing to next ingredient; manually advancing to next group.





1. Enter **461**.
2. Press .
3. Press  to select *ON* or *OFF*.
4. Press .

Drive ratio

[DRATIO]

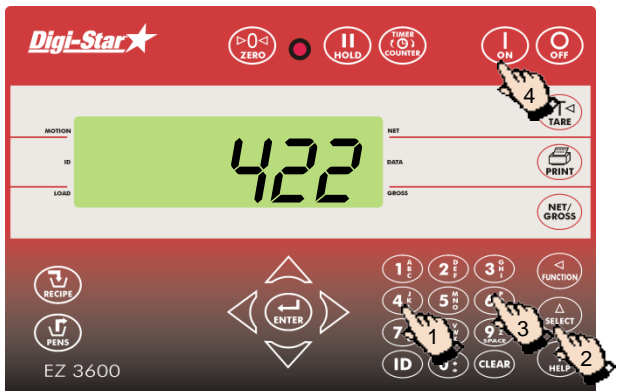
Drive ratio is the number of revolutions of the power take-off of the feed mixer divided by the number of revolutions of the mixer in the feed mixer.







1. Enter **422**.
2. Press .
3. Enter the required drive ratio.
4. Press .

Weighing indicator ID / feed mixer ID

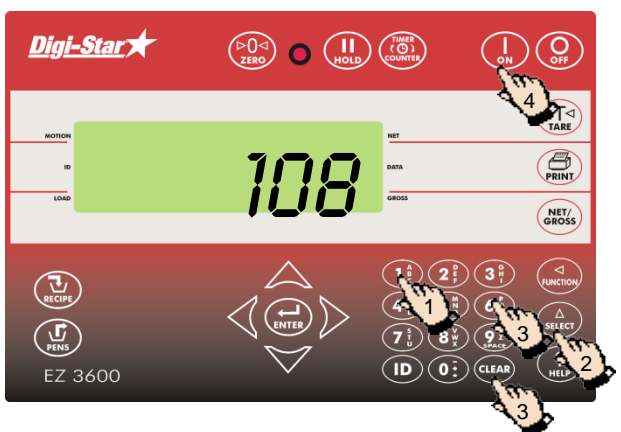
[SCALEID]

Each weighing indicator has a unique ID number.



1. Enter **108**.
2. Press .
3. Press  to delete the old ID number. Enter the new ID number.
4. Press .

Note: The TMR Tracker software ID number must correspond with the ID number of the feed mixer.

Radio number

[SCL NO]

The radio number is used in combination with the Cab control option.

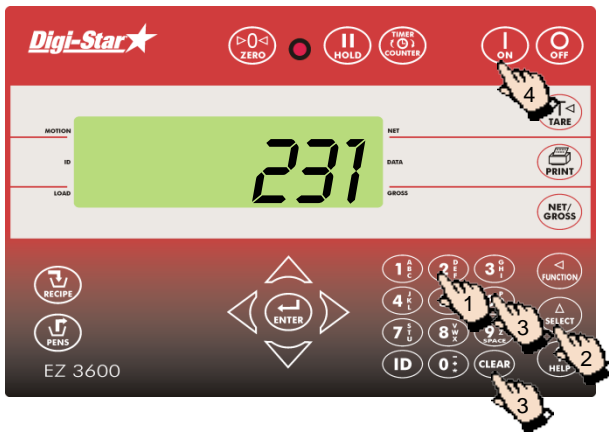

1. Enter **231**.
2. Press **SELECT**.
3. Press **CLEAR** to delete the number and enter the new number.
4. Press **ON**.

Note: Do not use the same number for two different weighing indicators.

Changing the recipe amount on the weighing indicator

[RESIZE]

When starting a recipe the total recipe weight can be changed or the number of animals in a group can be adjusted.



1. Enter **448**.
2. Press **SELECT**.
3. Press **SELECT** again to select *ON* or *OFF*.
4. Press **ON**.

Setting the time

[TIME]







1. Enter **202**.
2. Press **SELECT**.
3. Press **←** to move the cursor.
4. Press **→** to set the time.
5. Press **ON**.

Setting the date

[DATE]





1. Enter **204**.
2. Press .
3. Press  to move the cursor.
4. Press  to set the date.
5. Press .

TMR Tracker or Front Panel programming

[PROGRAM]



1. Enter **439**.
2. Press .
3. Press  again to select *PC* (Programming using TMR Tracker software) or *SCALE* (Front panel programming).
4. Press .

LIST WITH DIRECT ACCESS NUMBERS

1. Enter the direct access number and press  to go directly to the setting concerned.
2. Press  to change the setting.
3. Press  to store the setting.

Setting [display]	Access N°	Options [displayed] (bold=default)	Description	
MENU 1. BASIC FUNCTIONS IN MOST WEIGHING INDICATORS				
LANGUAGE [LANGAG]	101	English Dutch French German Italian Portuguese Spanish Danish Hungarian Vesta	[ENGLISH] [NEDERL] [FRANCS] [DEUTSH] [ITAL] [PORT] [ESPAN] [DANSK] [MAGYAR] [VESTA]	Settings and texts will appear in this language on the display.
WEIGHING INDICATOR ID SETUP [SCLID]	108	NEW EZ	Identity number of the weighing indicator [feed mixer number].	
MENU 2. TIME, PRINT, COMMUNICATION & WEIGHING FUNCTIONS				
TIME FORMAT [TIME F]	201	24 HR AM/PM	Time format: AM/PM or 24 hour	
1 TIME [TIME]	202	XX:XX:XX	Use Select and Function key to set the time	
DATE FORMAT [DATE F]	203	1-mm-dd 2-mm/dd/yy 3-mm/dd/yyyy 4-dd-mm 5-dd/mm/yy 6-dd/mm/yyyy 7-ddmmyy 8-ddmmyyyy	Date format.	
DATE [DATE]	204	Enter XXXXXX.	Use Select and Function key to set the date	
WEIGHING INDICATOR NR. [SCL NO]	231		Weighing indicator number to communicate with the Cab control.	
REMOTE DISPLAY [RMDISP]	234		Type of remote display.	

Setting [display]	Access N°	Options [displayed] (bold=default)	Description
MENU 3. CALIBRATION SETTINGS WEIGHING INDICATOR			
DISPLAY UNIT [LB-KG]	303	LB/KG	Display in lb or kg.
MENU 4. PRESET, RECIPE & COUNTER FUNCTIONS			
PREALARM [P-MTHD] & [P-ALM]	401	WEIGHT PERCNT	Select WEIGHT or PERCNT and enter a value to activate an early warning indicating that the weighing indicator is reaching the preset amount.
SIREN [BUZZER]	404	1-4, ON/OFF	Switching the loud alarm signal ON or OFF.
TIMER/COUNTER [TMCTR]	421	REV. TIME	Determination of the recipe mixing time based on time or on the number of mixing auger revolutions.
DRIVE RATIO [DRATIO]	422	0001.00	The number of input impulses (PTO revolutions), which correspond with one single revolution of the mixing auger.
TOLERANCE [TOLER]	442	OFF , 5,1-5,7,10	The tolerance (percentage of the ingredient amount) to accept the ingredient.
INGR. ADVANCEDELAY [DELAY]	443	MANUAL , 1-3,5,7, 10,20,30,60	The number of seconds the weighing indicator should wait before automatically advancing to the next ingredient.
USER ID [USERID]	446	ON/OFF	If this setting is <i>ON</i> , the operator should enter the user ID to use the weighing indicator.
RESIZING RECIPE. [RESIZE]	448	ON/OFF	If this setting is <i>ON</i> , the operator can adjust the recipe amount.
RECIPE TOTAL [RECTOT]	451	ON/OFF	Displayed total weight of the recipe to be loaded.
TOLERANCE OVERLOCK [OVERLK]	453	ON/OFF	If this setting is <i>ON</i> , the weighing indicator does not automatically advance to the next ingredient when exceeding the set tolerance.
FEED ZONE [FOZONE]	454	ALL , 1-9	The feed zone of the groups to be fed.

Setting [display]	Access Nº	Options [displayed] (bold=default)	Description
UNCOMPLETED RECIPES [UNDM I]	455	ON/OFF	If this setting is <i>ON</i> , the weighing indicator displays all uncompleted recipes.
AUTOSTART GROUPS [AUTPEN]	458	ON/OFF	If this setting is <i>ON</i> , the group list will automatically appear on the display after loading the ingredients.
MANUALLY ADVANCING TO NEXT GROUP [MANPEN]	461	ON/OFF	If this setting is <i>ON</i> , the operator should manually advance to the next group(s) to be fed.
GROUP TOLERANCE [T MTHD] & [PENTOL]	462	WEIGHT PERCNT	Select WEIGHT or PERCNT and enter of group tolerance.
DISPLAYED WEIGHT DURING FEEDING [PEN WT]	463	LOAD GROSS NET	The method of displaying during feeding: net, load or gross weight.
DOUBLE KEY PRESS PREV [DBLKEY].	465	ON/OFF	Select if a double key press should be ignored during loading and feeding.
RECIPE REMAINS ACTIVE [RE-USE]	466	ON/OFF	Select ON to re-use recipes.
CALIBRATION			
SETUP NUMBER [SETUP]	871		The unit of weight (1-4lbs or 5-8 kg), the gain (1-9), the sensitivity (display counts 1-9) and the capacity * 1000 can be entered using direct number entry.
CALIBRATION NUMBER [CAL]	872		Displayed amount at 0.4mV/V for these load cells.

TROUBLE SHOOTING

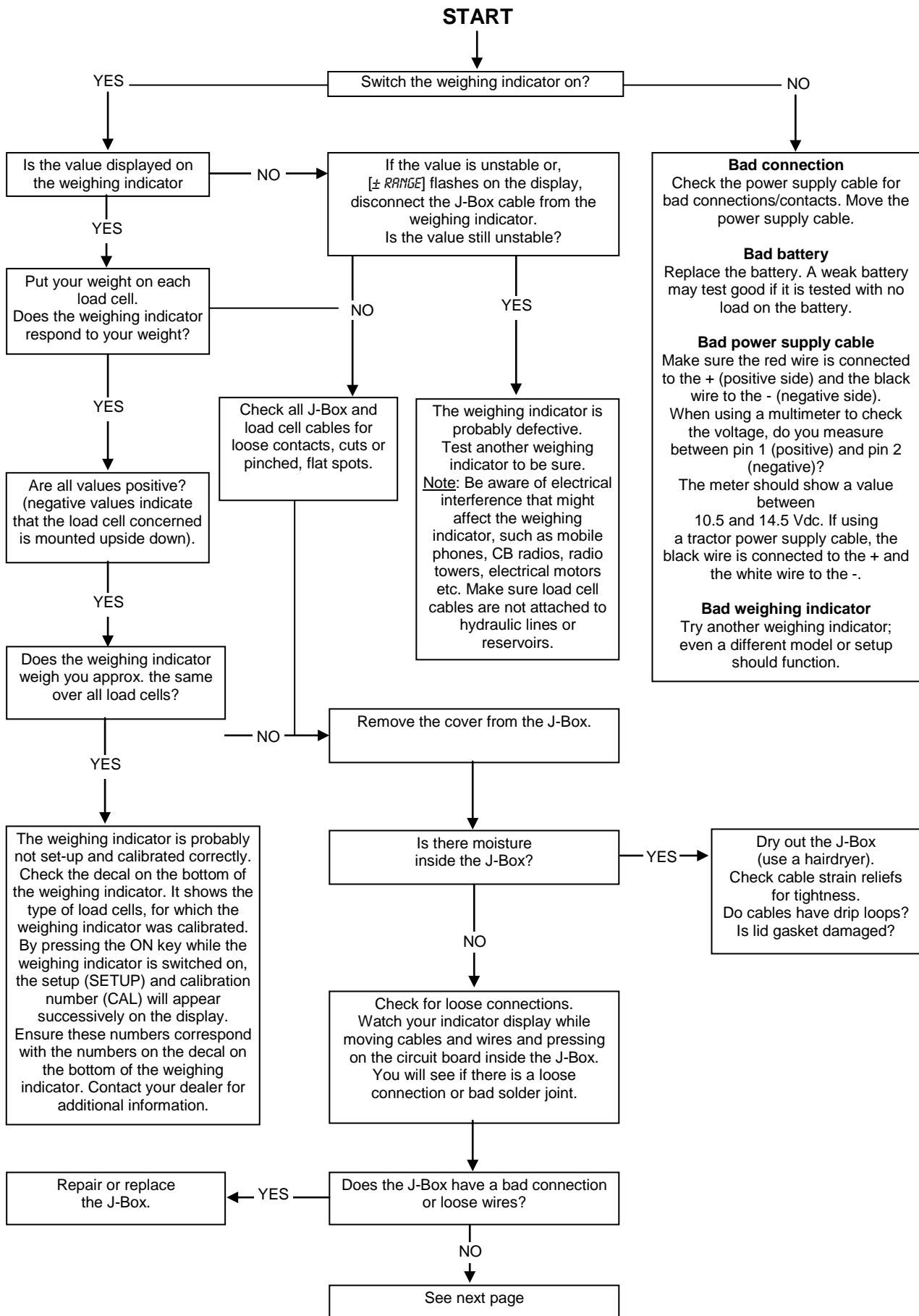

CONTINUED

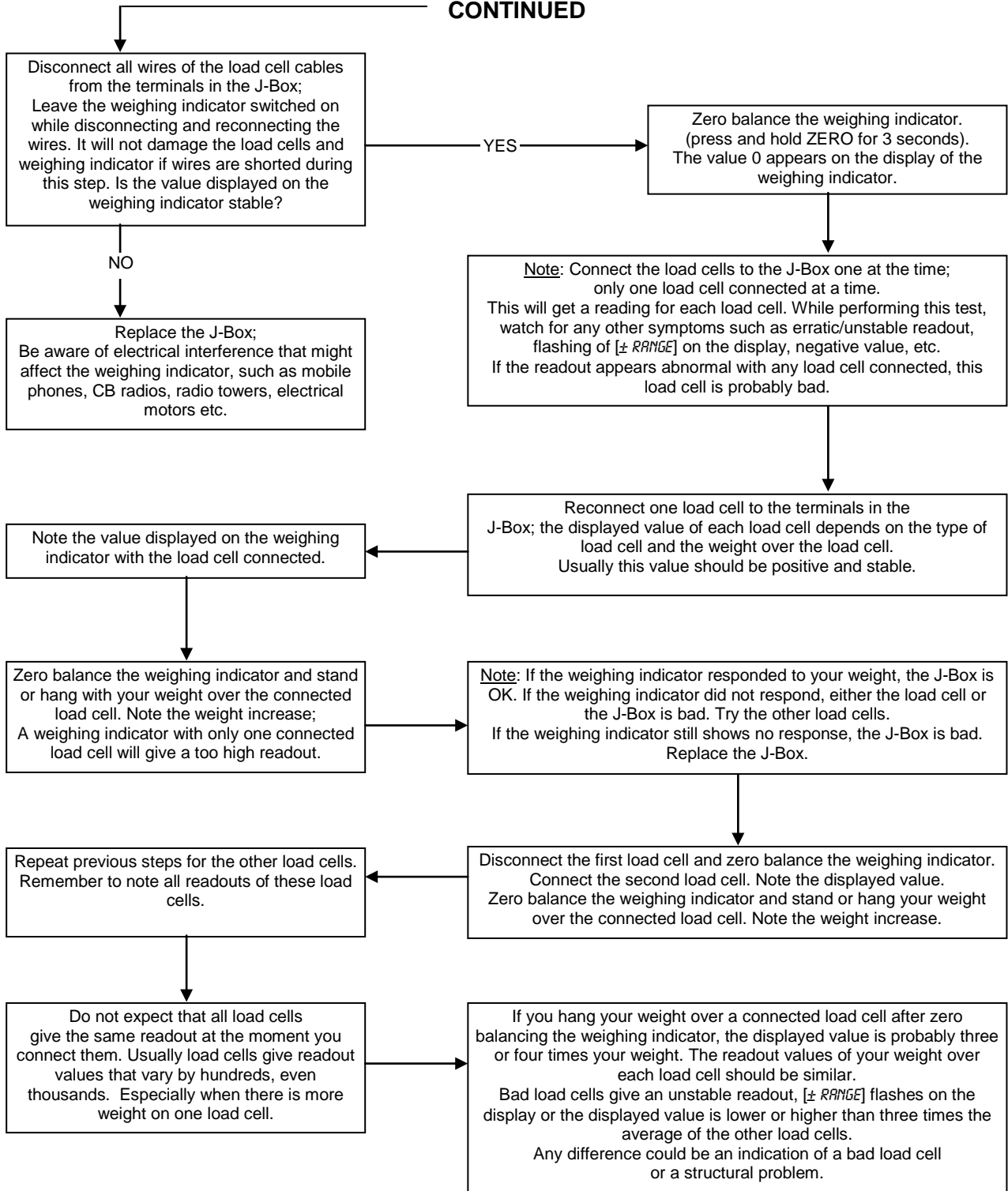

INSTALLATION

Mounting the indicator

Rail mounting included

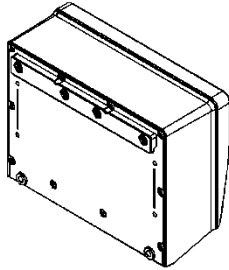

Wing mount included

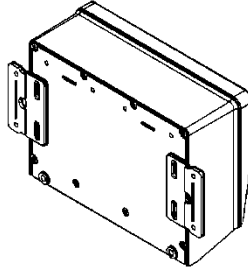

RAM mount optional

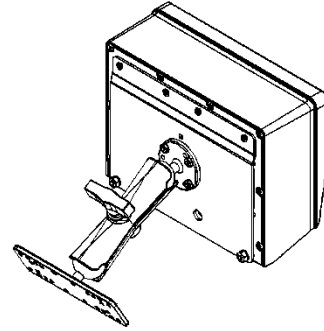
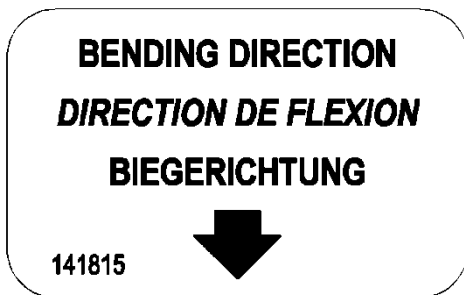

Figure 1: Mounting the weighing indicator

Rail mounting [standard] and wing mount included.
 RAM mount (option) included in RAM mount kit.

Load cell direction



Observe direction of arrow when installing load cell.

Connecting the cables

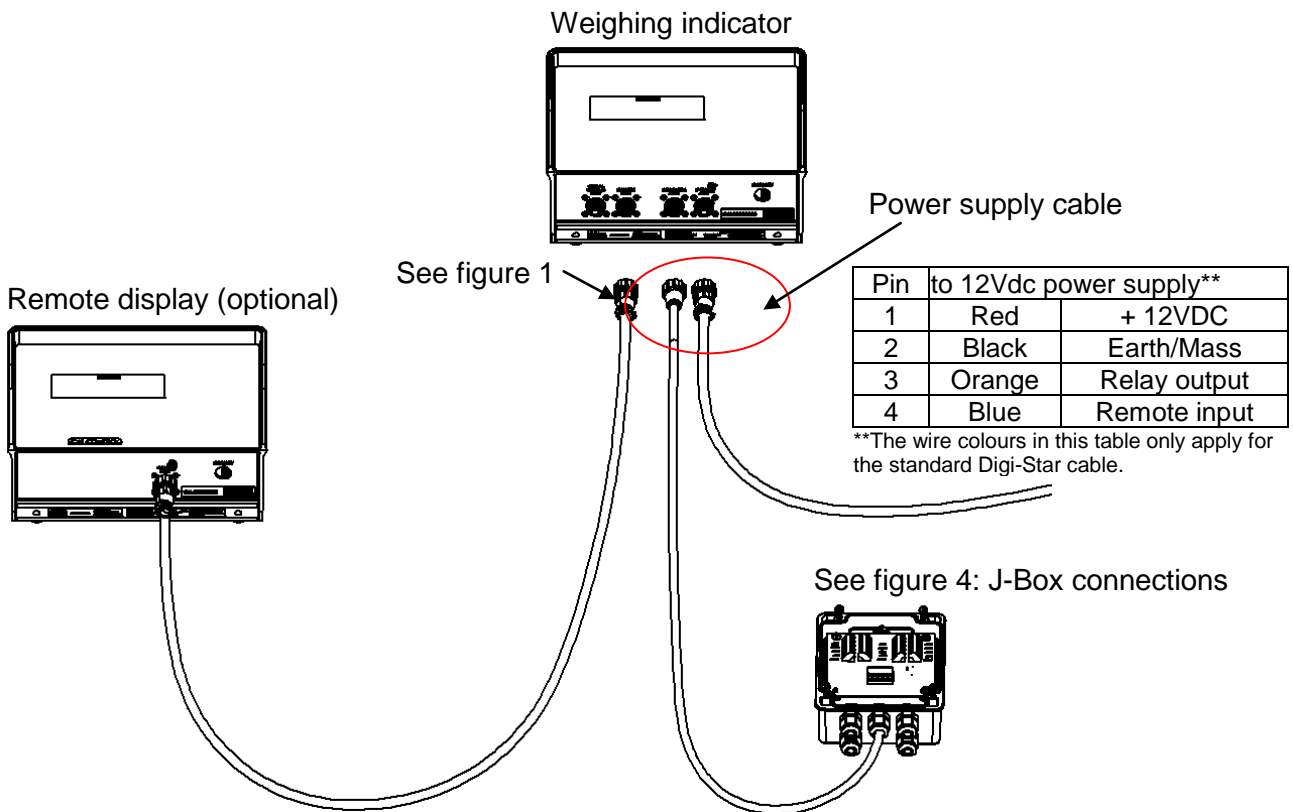

Figure 2: Connection diagram of weighing indicator

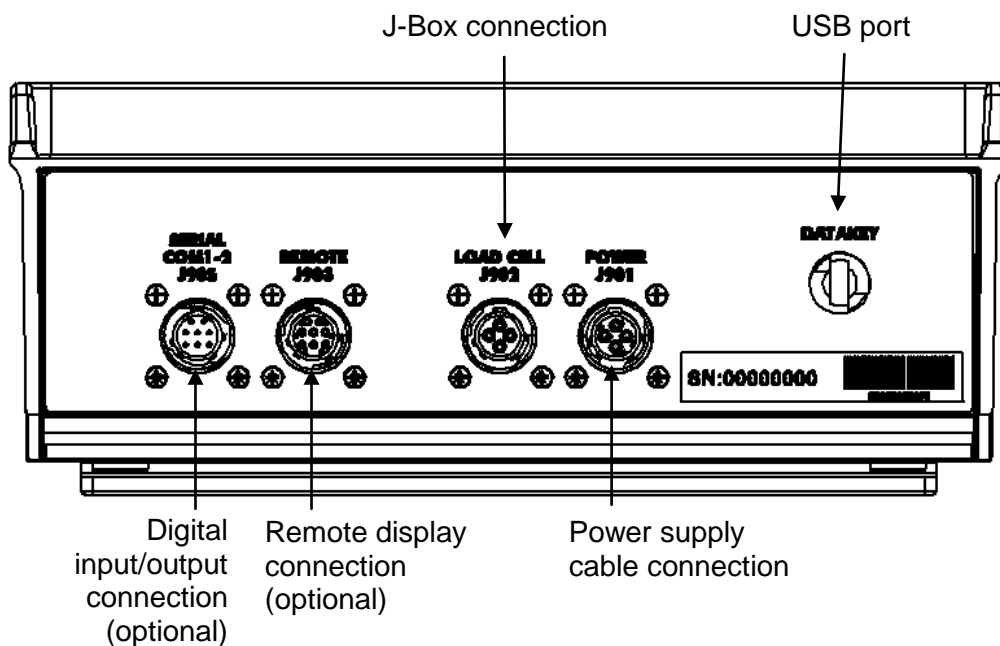
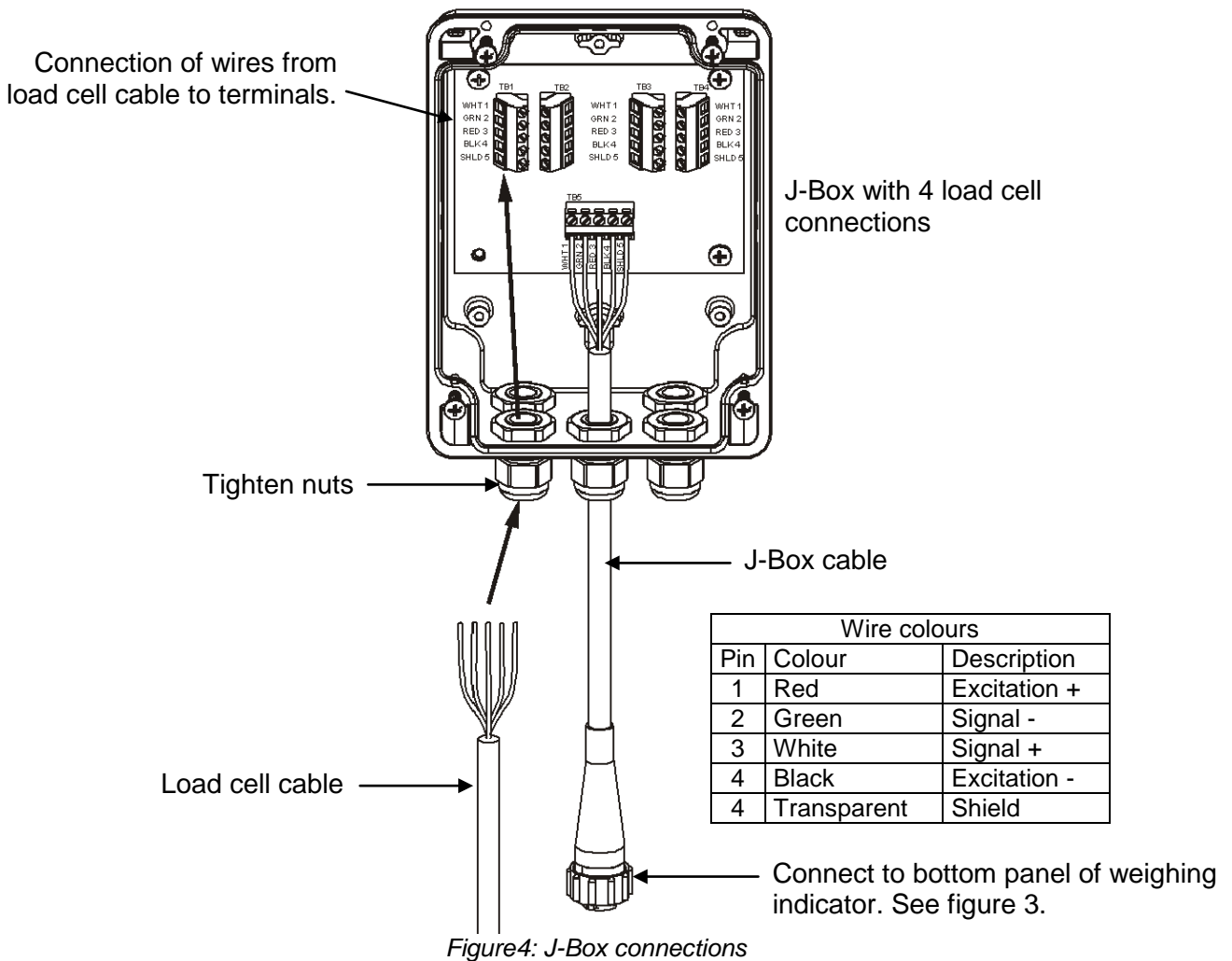

Figure 3: Bottom panel cable connections

Connecting load cells to J-Box



Changing setup and calibration numbers

[*SETUP*] & [*CAL*]

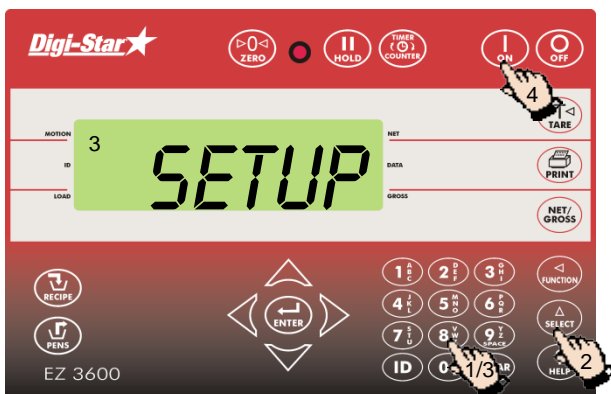

1. Enter **871**.
2. Press **SELECT**.
3. Weighing indicator briefly shows *SETUP* followed by a six digit number. Enter the new number.
4. Press **ON**.

Use **872** and follow the same procedure to change the calibration *CAL* number.

OPTIONAL EQUIPMENT

Rotation counter sensor

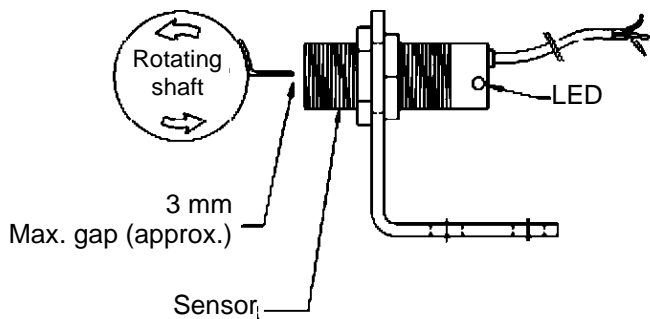

To be used in combination with the EZ3600 or EZ4600 weighing indicator, which is equipped with a rotation counter port (option).

The sensor allows the operator to program the weighing indicator to count the mixing auger or PTO rotations for an accurate mixing of ingredients.

Transmitter/receiver



Transmitter (shown left) with factory installed receiver in weighing indicator.

Can be used to manually advance from a distance during loading ingredients and feeding groups.

The system can also be used to zero balance the weighing indicator from a distance.

Operating range is approx. 50 m.

Remote displays



RD440 small remote display with 2,5 cm high digits.

RD2400V backlit remote display with 4,3 cm high digits.

RD4000 LED remote display 10 cm high digits.

APPENDIX A1: EC DECLARATION OF CONFORMITY

Application of Council Directive(s)	2004/108/EEC
Manufacturer's Name	Digi-Star, LLC
Manufacturer's Address	790 West Rockwell Avenue, Fort Atkinson, WI 53538
European Representative Name	Digi-Star Europe B.V.
European Representative Address	J.F. Kennedylaan 235, 5981 WX Panningen (NL)

Model name EZ2400, EZ2400V, EZ3400, EZ3400V, EZ3600, EZ3600V, EZ4600, SW2600EID, SW4600EID, RD2400V, CAB CONTROL 2400\2400V\3400\3400V\3600\3600V

Conformance to:

- EN 61326 - electrical equipment for measurement, control and laboratory use (see Report Number 307245.)
- EN 55011 - for Class B ISM equipment for industrial, scientific, and medical equipment (see Report Number 307245).

Beginning serial N°: 1001
Year of Manufacture: 2008

We, the undersigned, hereby declare that the equipment specified above conforms to the above Directive(s).

Manufacturer



Legal representative in Europe

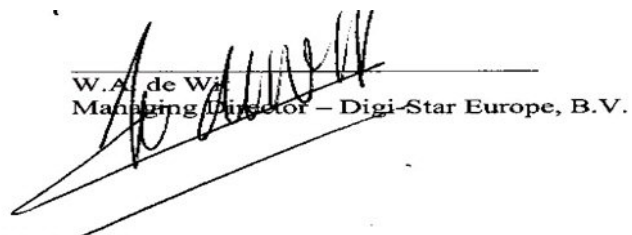

W. A. de Wit
Managing Director – Digi-Star Europe, B.V.

Signature

Name: Kevin Klubertanz
Position: Director of Engineering
Place: Fort Atkinson, WI U.S.A.
Date : 15 March 2008

Signature

Name: Wim de Wit
Position: Managing Director
Place: Panningen, the Netherlands
Date: 15 March 2008